

JETVARNISH 3D

Digital varnish & iFOIL

***Digital Inkjet Spot UV Coater
With Tactile Effects
and Hot Foil Stamping.***

52x105 cm - 20x42"



Innovation in Motion

TAKE YOUR PRINTS TO..

THE TECHNOLOGICAL REVOLUTION: ARTIFICIAL INTELLIGENCE SMARTSCANNER® (AIS)

The *MGI AIS SmartScanner* is a revolutionary registration development for the printing and finishing industry:

- Eliminates more than 80% of operator setup time spent on registration processes, and reduces make-ready waste
- Allow quick and seamless integration within job workflows with simple, automatic “scan and register” setup process
- Supports rapid equipment amortization with increased throughput, faster job completion and greater productivity
- Removes unnecessary operator wage costs & paper makeready waste associated with analog setup processes

The *AIS system* uses Artificial Intelligence to create an automatic varnish and hot foil registration for inkjet heads over the preprinted sheet. It is fully compatible with *Variable Data Printing (VDP)* jobs. Using print image and inkjet synchronization algorithms, the exclusive and patented AIS system runs at more than 5,000 billion of operations per second. Without operator intervention or a decrease in feeding speed, it makes corrections and adjustments for any defects generated by the original offset or digital printing run and any lamination process.

Examples :

- Sheet and image skew
- Sheet and image shift on X and/or Y direction
- Sheet and image stretch – partial or total
- Sheet and image contraction – partial or total

“ARTIFICIAL INTELLIGENCE THAT DOES THE WORK FOR YOU.”

Defects automatically adjusted by AIS SmartScanner system

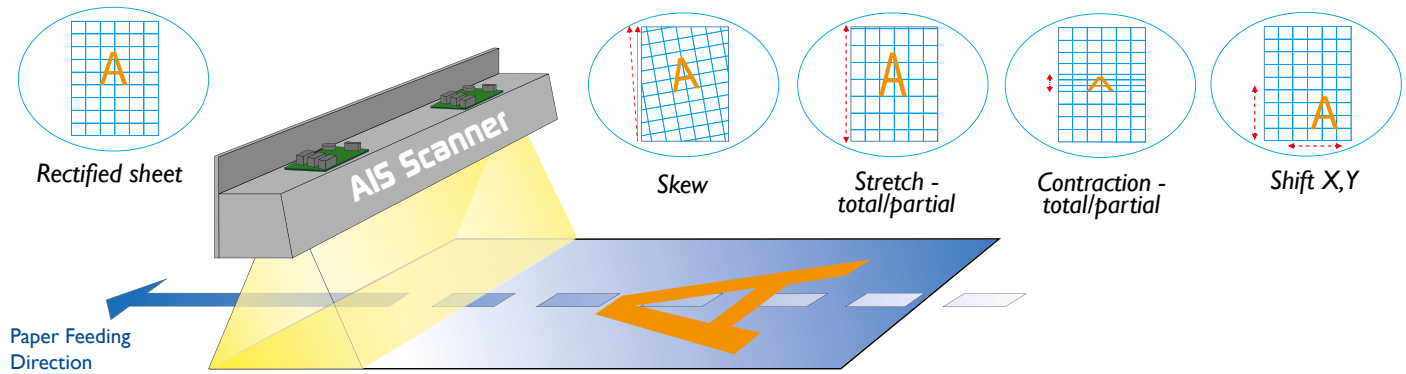

SOFTWARE SUITE AND TOUCHSCREEN INTERFACE

The *JETvarnish 3D* has an innovative software suite developed by MGI that includes management tools such as: a job cost calculator, workstation image editor, reprinting utility, *AIS SmartScanner* setup and variable data controller. All job management functions operate via intuitive touchscreen interface. This software suite allows operators to manage all operations related to production and maintenance, via the workstation interface.

JOB COST CALCULATOR

Based on your job's image file, this powerful calculator forecasts varnish consumption costs down to the penny. This has never been possible before on traditional spot coating technologies. This powerful function automatically calculates precise production costs in advance of actual production. It is a valuable tool for managing supply costs and making accurate job estimates. This software can be also available on a PC for your pricing and sales departments.

SPOT VARNISH EDITOR

An easy to use graphical tool designed by MGI for editing job files at the workstation. This utility allows production operators to quickly modify enhancements without going back to prepress. This software saves time and allows operators to set up jobs in minutes and conduct rapid prototyping directly from the equipment workstation. Varnish and foil enhancements are designed for high production work environments.

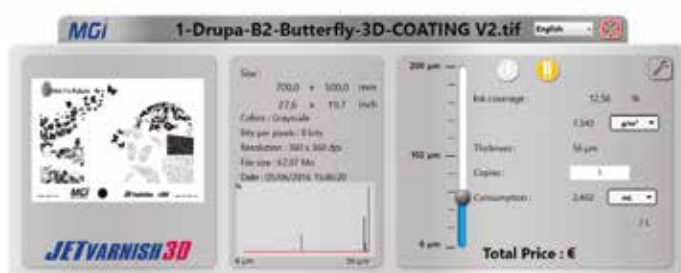

...A WHOLE NEW DIMENSION...

MGI pioneered the development of digital postpress enhancement technology with the first *Inkjet Spot UV Coater* in 2008, the original JETvarnish. Since then, MGI has installed more *Digital Spot UV Coaters* than anyone else in the industry.

The MGI Flagship makes a metamorphosis with a new look inspired by JETvarnish 3D Evo.

The *JETvarnish 3D* takes digital spot UV coating to a new dimension, featuring increased throughput for *flat spot UV* jobs and amazing *3D raised effects*. Ideal for operations with digital and offset presses up to *52x105 cm (20x42")* format, providing added value and a sensorial dimension to your printings. You can also produce *prototypes* and «ready for press» for an affordable price.

Gain new customers and explore profitable market opportunities : your clients will receive visually stunning, tactile pieces that allow them to differentiate themselves from their peers.

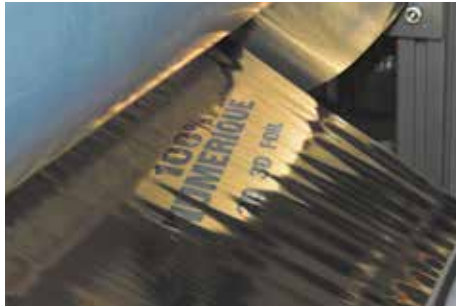

iFOIL L MODULE

With OptiFoil film optimization & foil roll management



NEW REVOLUTIONARY AIS SMARTSCANNER

Each sheet is scanned and checked
NO registration marks
NO make ready time wastes

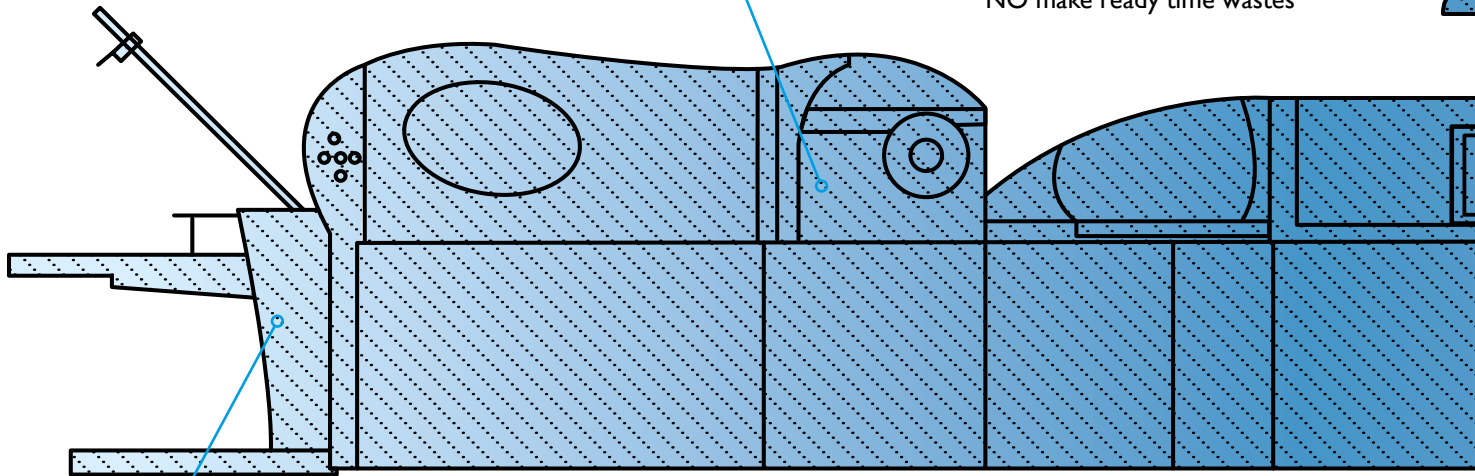

SHEET STACKER

Feed widths up to 52 cm / 20"



VARIABLE DATA PRINTING

Optional document personalization

...WITH MORE FEATURES...

The *JETvarnish 3D* allows for fast startup without plates, screens or waste, producing anything from one to several thousand sheets per hour with ease. On the same document, the *JETvarnish 3D* can change the coating thickness from **3 to 200 microns**, depending on the user's defined areas.

With extended formats ranging up to **52x105 cm (20x42")** and weights **up to 600 gsm**, you can use the *JETvarnish 3D* to upsell each one of your regular printed jobs into high margin spot UV jobs.

The 100% digital *JETvarnish 3D* allows you to take a few sheets from a job and spot UV coat it, producing a sellable proof so your customers can see the potential and additional visibility and impact that their jobs could have.

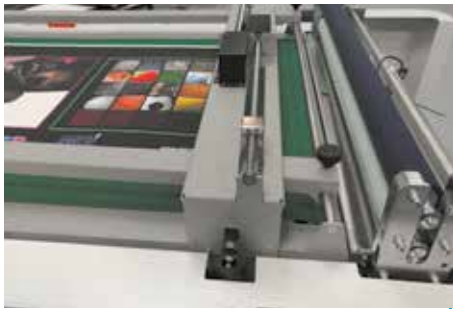

NEW MARGIN TABLE

Motorized guides for improved productivity



CORONA

In-line system made to optimize varnish adhesion on complex printed substrates

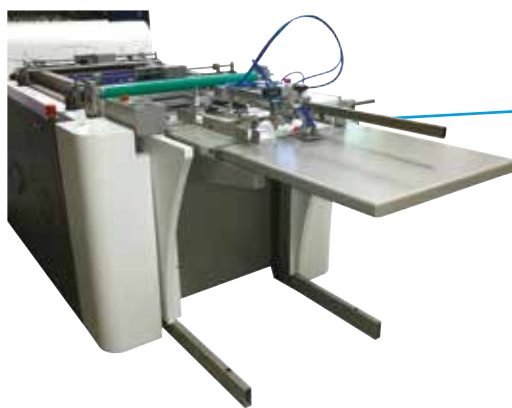
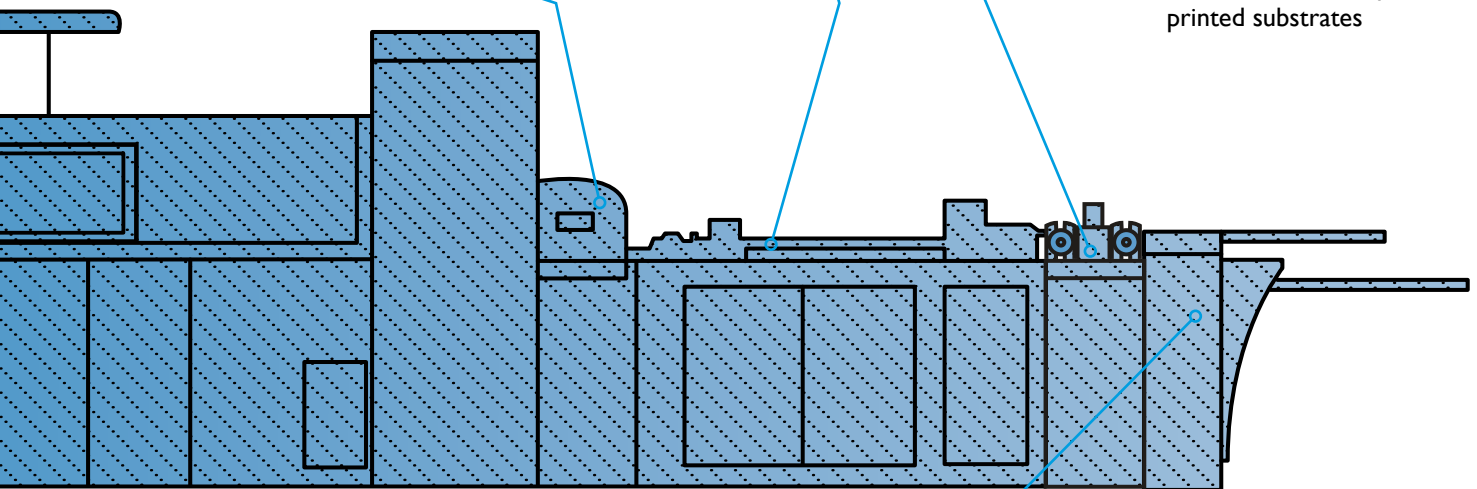

SHEET FEEDER

Feed width up to 52 cm / 20"



ENVIRONMENT

Enhanced UV protection with lower energy consumption than traditional UV systems.

No makeready, no plates (offset), no screens (silkscreen), no dies (hot foiling), no waste (electricity, paper, varnish and time).

Reduction of consumables (elimination of many plastics). Closed-circuit system to minimise varnish consumption, thus preventing waste.

iFOIL - DIGITAL EMBOSSED AND HOT FOIL STAMPING

The *JETvarnish 3D* offers a fully integrated, inline option to add the award-winning *iFOIL Hot Foiling System*. This module can be installed at the time of purchase or in the future as a field upgrade.

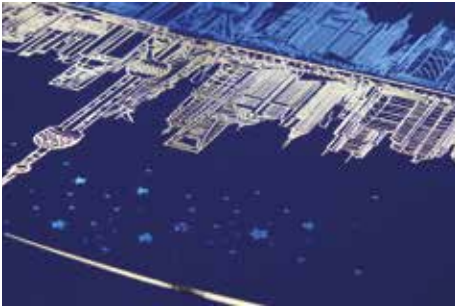

This functionality produces digital and variable embellishments such as very fine lines, small lettering and detailed texture effects on each piece. It is both a perfect prototyping tool and a complete high-volume production solution.

Through a revolutionary digital process, the *iFOIL* eliminates the need for films, dies, screens and makeready. This allows quick and easy production of foil stamping jobs from one to thousands of sheets.

This scalability of foil customization and personalization enables printers and trade finishers to expand into profitable new markets segments.

Spectacular and unique effects are now available within a 100% digital process:

- Embossing
- Multiple colored foils applied in one pass (up to 5 colors)
- Variable data foiling (VDF) with 2D/3D UV Coating
- Foil over foil to create dramatic special effects
- Unique capability to foil and emboss on plastic (including on Polypropylene/PP)

The *JETvarnish 3D* and *iFOIL* combination creates both visual and tactile excitement that print buyers, end-users and brand owners are looking for, to distinguish their products in the marketplace. The software suite simplifies layout mask changes on sheets ranging from 21x29.7 cm / 8.27x11.7" up to 52x105 cm/20x42" and on substrates ranging from 150 up to 600 microns (µm).

It is designed to produce brilliant foil effects on jobs printed on offset, flexo and digital presses. Foil can be applied on coated/uncoated papers, synthetics, plas-



tics, laminated films and aqueous coated surfaces.

Adding inline digital foil adds value and profitability while reducing outsourcing costs and job completion delays.



VARIABLE DATA PRINTING (VDP)

The *Variable Data Printing* option adds full *personalization* capabilities for maximum marketing impact.

Push your documents personalization beyond the limits with *varnish* and *hot foil stamping* variable data printing.

Make basic customization with standard information as name, address, sentence, basically with text. Or realize *full customization* with multiple criteria as *images*, *texts*, *layout*, etc, to reach an unique piece.

Optical "on-the-fly" variable data system uses camera and preprinted barcodes. With the Variable Data Printing option, a high-performance PC RIP with software and a barcode camera are included.

Generate your flow directly in and let the *JETvarnish 3D* amaze you.



Technical Specifications

UV INKJET TECHNOLOGY

- MGI's exclusive inkjet engine technology.
- Drop-on-Demand (Dod) inkjet application.
- Piezoelectric print heads in single pass printing.
- Flexible & scalable architecture.

VARIABLE COATING THICKNESSES

Depending on your file and the substrate used, the coating thickness can vary from a traditional flat spot UV coating of 3 microns (μm) up to 200 μm for 3D raised texture effects and a tactile finish.

PRODUCTION SPEED

Up to 3,123⁽¹⁾ B2 sheets size per hour (flat spot UV coating or 2D).

REGISTRATION

Left & right motorized registration side guides. Automatic registration using the built-in AIS SmartScanner technology for real-time management of entire sheet. No registration marks required. Overall registration of ± 200 microns.

MANAGED PAPER FORMATS

- Min:** 21x29.7 cm / 8.37x11.7" (width x length)
Max: 52x105 cm / 20x42" (standard)
 57x120 cm / 22.4x47" (extended)⁽²⁾
 64x120 cm / 25.2x47" (extended)⁽³⁾

PRINTABLE WIDTH AREAS

- 51 cm / 19" (standard)
 54 cm / 21.3" (extended)⁽²⁾⁽³⁾

SUBSTRATE THICKNESS

- Min:** 135 gsm and not less than 150 μm / 6 mil before printing & lamination.
Max: Up to 600 gsm.

SUBSTRATE COMPATIBILITY

Enhancement on most⁽³⁾ matte or glossy laminated surfaces, with or without aqueous coating, layered paper, plastic, PVC and other coated materials. Spot 3D coat directly onto most⁽³⁾ digital prints (ie. MGI Meteor).

UV COATINGS AND YIELDS

Several coating formulas available, one dedicated to 2D (flat coat) and the other for 2D/3D usage. The JETvarnish 3D comes standard with 2 coating tanks and 2 coating circuits allowing a quick changeover between coatings. Tanks have a high capacity volume (18 liters / 4.7 US gal.). "On-the-fly" tank refilling possible during production without any interruption and no waste.

HIGH CAPACITY AUTOMATIC FEEDER

High capacity feeder able to handle a paper pile up to 60 cm/23.6" high for 52x105 cm (20x42") sheets. Approximately 4,000 sheets at 135 gsm.

HIGH PILE OUT STACKER

High capacity stacker able to accommodate stakes up to 60 cm/23.6" high for 52x105 cm (20x42") sheets. Approximately 4,000 sheets at 135 gsm.

PAPER PATH

- 100% flat paper path.
- Vacuum feed system.
- Air feed system.
- Automatic double sheet detection.

IN-LINE UV DRYER

"On-the-fly" drying & curing via integrated UV lamp.

FRONT END SYSTEM

- Intuitive touchscreen software management suite controlled by a 27" monitor.
- Includes functions for operators: Job cost calculator, image editor, queue manager and reprint, camera and print-heads settings.
- Dedicated controller for equipment settings and technical data.
- Ethernet connection 10/100/1000 BT in RJ 45.

iFOIL L

Optional Digital Hot Foiling module application.

- **Production Speed**
Up to 1,750⁽¹⁾ B2 sheets size per hour (or up to 25 m per minute - 65.6ft per minute).
- **Films**
Optimization system of film consumption.
- **Film Rolls**
Max. roll diameter and length : ± 30 cm/11.8" and from 400 to 2,000 meters of film (1,300 to 6,500 ft). Up to 3 simultaneous film rolls on the same axis (with a minimum of 10 cm/3.9" per roll).
2 cores available : 1 inch and 3 inches.
- **Maximum Surface**
Hot foil substrate surface can not exceed 51x104 cm (20.1x41")⁽⁴⁾ or 54x118 cm (21.3x46.5")⁽²⁾⁽³⁾.
- **Embossing**
3D hot foil raised effects.
The surface of the metallized film may be covered with a layer of varnish or another foil.

OTHER OPTIONS

- **Corona⁽⁵⁾⁽⁶⁾ Substrates treatment module**
In-line system made to optimize varnish adhesion on complex printed substrates
- **L or XL Pallet Feeder**
support sheets up to size 57 or 64x120 cm /25x47"
- **L or XL Pallet Stacker**
support sheets up to size 57 or 64x120 cm /25x47"
- **Variable Data Printing (VDP)**
 - Manage and edit files on the workstation
 - Full variable data (text, graphic, image) for both 2D/3D Spot Coating and Hot Foiling areas
 - Integrated barcode (1D/2D) reader system & controller
 - Raster Image Processor (RIP) as an option

REMOTE TECHNICAL SUPPORT & MAINTENANCE

- Daily maintenance completed in less than 10 min.
- Majority of procedures are automated.
- From cold start to production in less than 15 min.
- Remote troubleshooting & support via included web video camera (high speed internet connection required).

DIMENSIONS AND WEIGHT

JETvarnish 3D + iFOIL
 From 8.03 up to 12.72x1.76x1.81 meters⁽⁷⁾
 From 26.35 up to 41.73x5.74x5.94 ft (L x w x h)⁽⁷⁾
 Necessary clearance : 1 meter (3.3ft) on 4 sides.
 Up to $\pm 4,278$ kg / 9,431 lbs⁽⁷⁾

DRY AIR REQUIREMENTS

An onsite dry air system is necessary.

ELECTRICAL REQUIREMENTS

- JETvarnish 3D
400 Volts - 50/60 Hz, 32A (63A plug)
- iFOIL L
400 Volts - 50/60 Hz, 25A (32A plug)

OPERATING ENVIRONMENT

Temperature : from 18 up to 30°C / 64 up to 86°F
 Relative humidity between 30 and 50%
 (no condensation)

The default sheet size is B2 ISO (50x70.7 cm/19,7x27,8") unless otherwise stated.
 All speeds are nominal.

- (1) speed will vary according to printing parameter used.
- (2) with the L pallet feeder and stacker options
- (3) with the XL pallet feeder and stacker options
- (3) confirm substrate/lamination/toner/metallic film compatibility with MGI.
- (4) standard configuration
- (5) require substrate above 42 cm width.
- (6) require paper above 250 Gsm / 250 μm .
- (7) depending on the configuration selected.

This is not a contractual document and technical specifications subject to change without notice.
 All the other trademarks cited are marks registered by their respective manufacturers.
 Operator / end-users are invited to submit substrates and foils to MGI for validation.